



AltRider Headlight Guard for Honda Africa Twin

INSTALLATION INSTRUCTIONS

The most up to date instructions can be downloaded from the product page at altrider.com, under the instructions tab.

Dear Rider,
Thank you for choosing AltRider! Whether a seasoned world adventurer or a first time ADV-Newbie, we welcome you to the AltRider experience. You can install your new product with the utmost confidence. AltRider designs, tests, and manufactures all of its products here in the United States. We are proud to do what we do, and honored to present to you the product of our labors.

Enjoy it, show it off, and most of all, RIDE IT!

Venture On,
Jeremy LeBreton

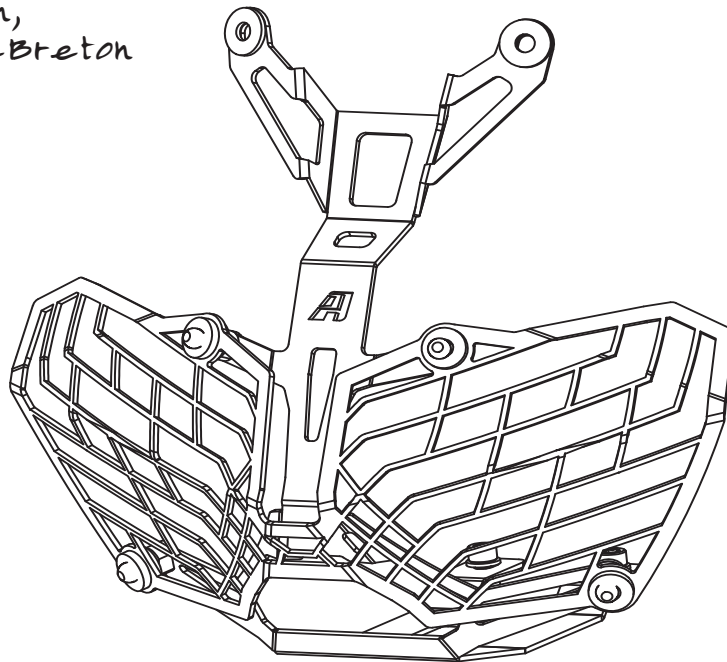

AltRider Headlight Guard
Honda Africa Twin

Package Contents:
- Headlight Guard
- Hardware kit

AltRider LLC

Global

mailing: 4000 Aurora Ave N Ste 100
Seattle, WA 98103 USA
phone: 206-922-3618
email: info@altrider.com
web: www.altrider.com

Europe

mailing: AltRider EU
Heliumstraat 230
2718 RS Zoetermeer
The Netherlands
email: info@altrider.eu
web: www.altrider.eu

MADE IN THE USA



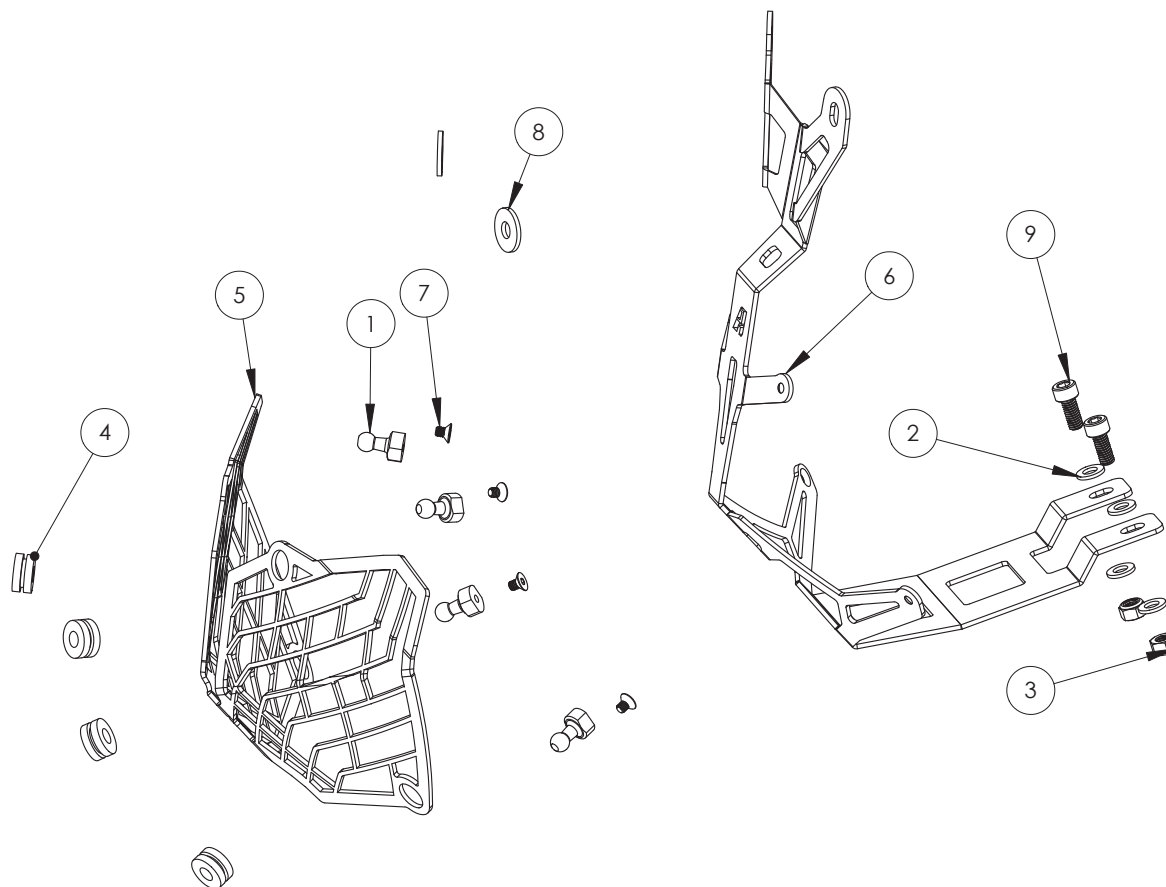

Kit:

paper instructions

- ① (4 qty) Ball studs with M4 female thread
- ② (4 qty) M6 washers
- ③ (2 qty) M6 lock nuts
- ④ (4 qty) rubber grommets
- ⑤ Mesh lens
- ⑥ Bracket
- ⑦ (4 qty) M4 x 6mm flat head screws
- ⑧ (2 qty) Nylon washers
- ⑨ (2 qty) M6 x 14mm socket cap screws



Tools necessary:

- ① 2.5mm allen tool
- ② 5mm allen tool
- ③ 10mm socket
- ④ ratchet handle
- ⑤ driver handle
- ⑥ 10mm combination wrench
- ⑦ Thread locker (medium strength)

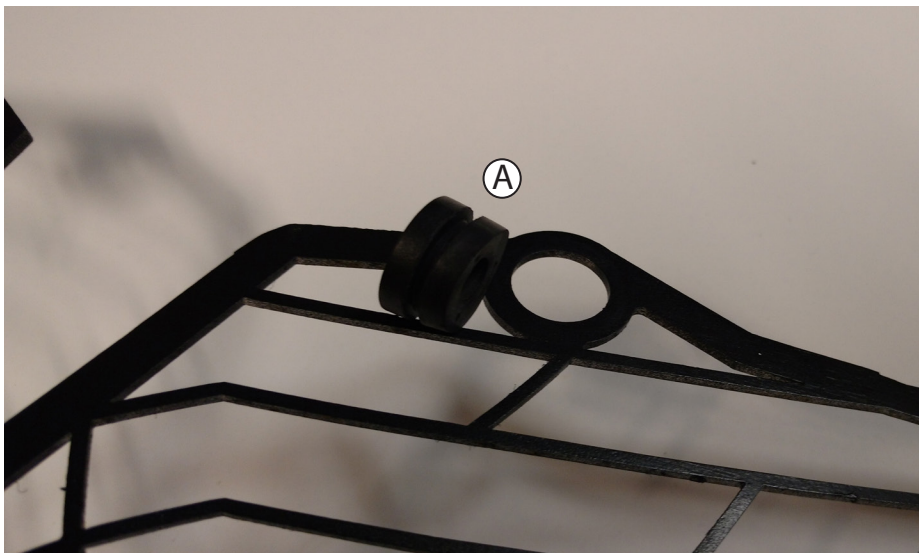

- ① Install four (4) rubber grommets into headlight guard. (A) Use care to not rip the rubber. **!TIP** a dab of water will help them slide into place, a small dull flathead screwdriver is a good tool to use.

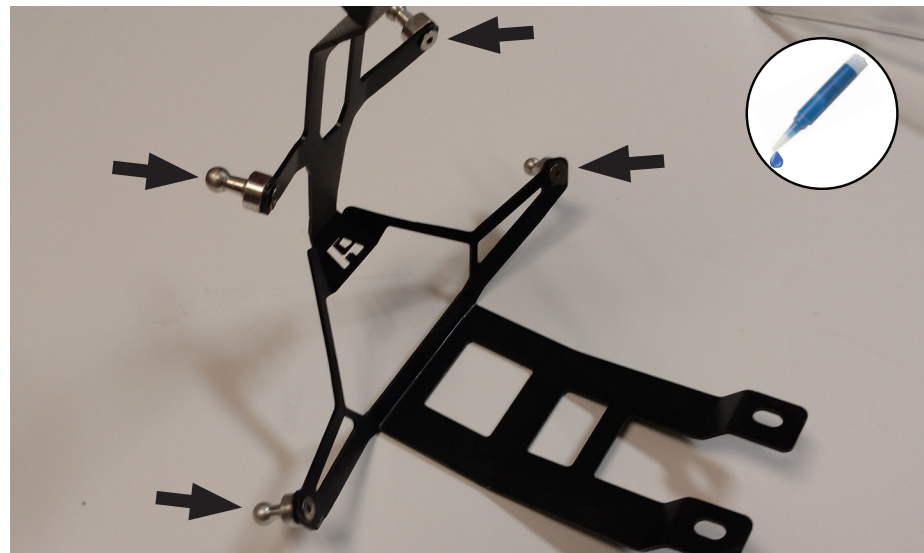

- ② Attach (4 qty) ball studs to bracket with (4 qty) M4 flat head screws. Apply a drop of thread locker to each screw. Use 10mm open end wrench and 2.5mm allen to tighten to 2.3 Nm.



- ③ Use 5mm allen tool and remove four(4) windscreen screws. Remove windscreen. Save these for reinstallation. **!TIP!** Make sure all four OEM rubber well nuts remain securely in place.

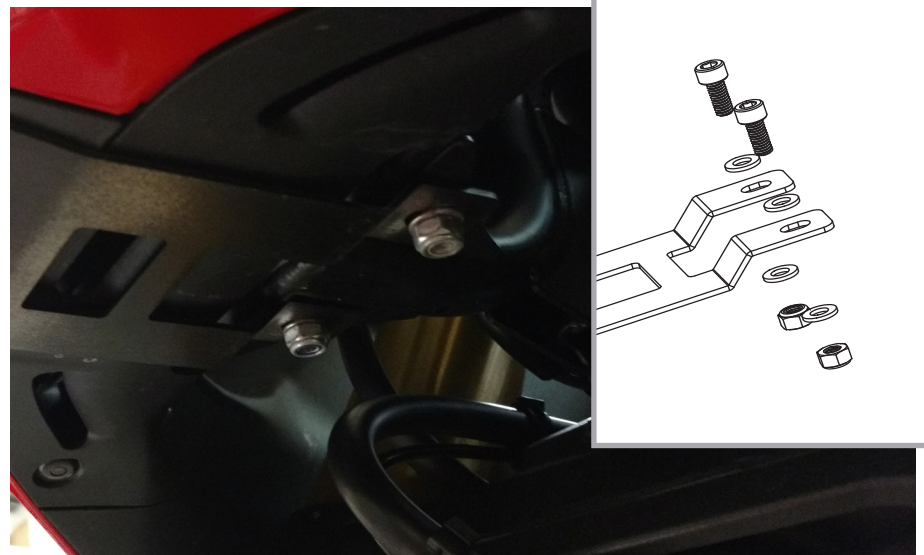

- ④ Use (2 qty) M6 x 14mm socket cap screws, (4 qty) M6 washers, and (2 qty) M6 lock nuts to loosely attach bracket to the mounting points under the nose of the bike, as shown.

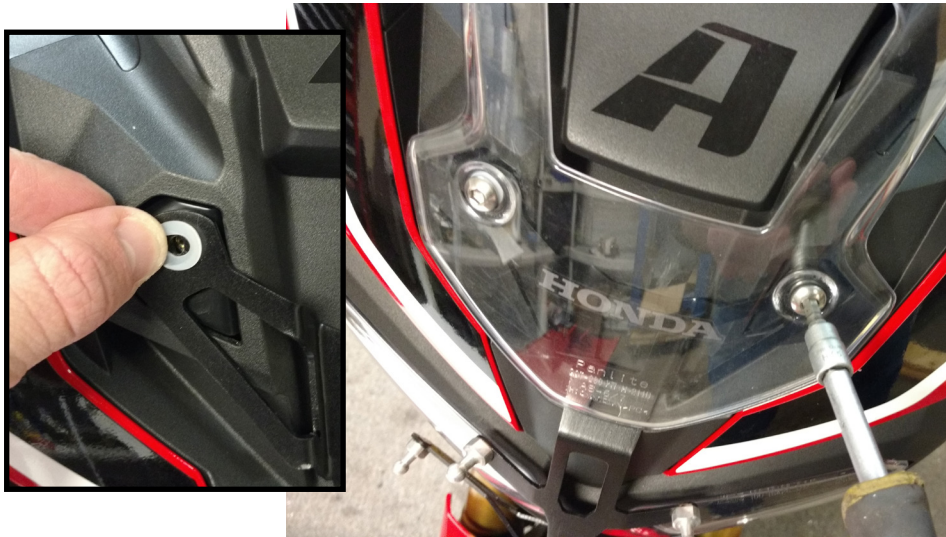

⑤ Attach bracket at upper mount points with windscreen. Use one M6 nylon washers on top of bracket at each screw as shown. Screw loosely in place.

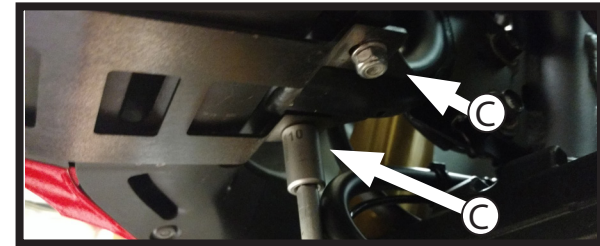
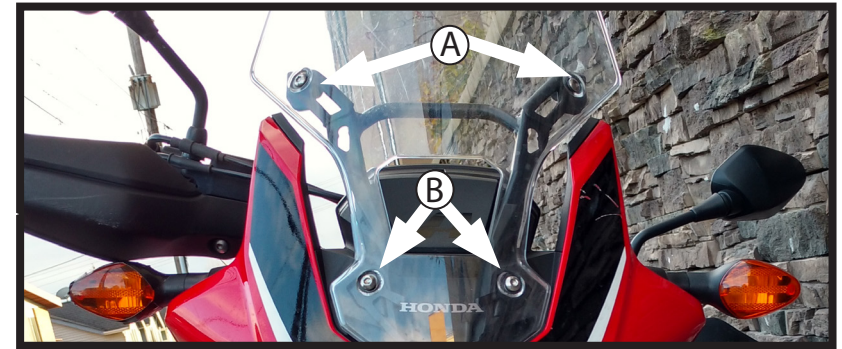

⑥ (A) Attach upper windscreen mounting screws.
 (B) Tighten all windscreen screws to 4 Nm.
 (C) Tighten M6 screws with locknuts under the nose to 7.8 Nm.



⑦ Install headlight guard. **!TIP** A dab of water on each ball stud will help it fit in place easier with less wear on the rubber grommets.



Polycarbonate Headlight Guard Cleaning Instructions

Clean your headlight guard using **ONLY** mild soap and water, dry with a soft cloth. For particularly stubborn bug guts, remove and soak in water, or place a wet soft towel on the lenses and allow to soften the debris.

DO NOT USE OTHER CHEMICALS to clean your headlight guard, such as windex, rubbing alcohol, acetone, simple green, ammonia, bike wash etc.

The polycarbonate plastic lenses are very tough and impact resistant, but will break down over time when exposed to harsh chemicals.

CONGRATULATIONS!

You've completed your installation. If at any point you have questions about your installation or have any feed back for us, we'd love to hear it. A downloadable version of these instructions can be found at our web site. www.AltRider.com

After 5 hours or 100 miles of riding, check your newly installed equipment to ensure all hardware is secure.

Global Office:

email: info@AltRider.com
phone: +1 206-922-3618
address: 4000 Aurora Ave N
Ste 100
Seattle, WA 98103

Europe Office:

email: info@AltRider.eu
address: Heliumstraat 230
2718 RS Zoetermeer
The Netherlands

TERMS OF USE, WARRANTY AND LIABILITY WAIVER

AltRider LLC, a Washington company, having its principal place of business in Seattle, WA ("AltRider") offers its motorcycle accessories (the "Product") with the terms, conditions and notices as follows:

Terms of Use

This Product is offered to you conditioned upon your acceptance without modification of the terms, conditions, and notices contained herein. Installation and/or use of this product implies acceptance of all such terms, conditions, and notices. If you do not agree to these terms, do not buy the Product. If you have already bought the Product and do not agree to these terms, return this Product promptly including the packaging and all written materials, to AltRider.

Limitation of Liability and Warranty Disclaimer

You may return your merchandise for a full refund or exchange, less any original or return shipping fees under these conditions:

1. Only if the merchandise is in 100% factory condition. Original manufacturer's packaging and same condition as sold – original boxes, packaging material, instructions, documentation, parts, and attached tags.
2. Only unused, unscratched, uninstalled, undamaged merchandise will be accepted. Do not install equipment until you are sure you want to keep it. Package items carefully in protective materials before returning them. Never ship an item in its original manufacturers packaging – it will arrive damaged. Please use a postal box or other adequate packaging to ensure your return or exchange is not damaged on the way back to AltRider.com.

To read more about our exchanges and returns policy, on the web, navigate to <http://www.alt rider.com/info/exchangesAndReturns>

Excepting the warranties stated in the preceding paragraph, AltRider hereby disclaims all other warranties and conditions with regard to the Product including all implied warranties and conditions of merchantability and fitness for a particular purpose. There are no warranties which extend beyond the description on the face hereof. AltRider does not warrant against damages or defects arising out of use or installation of the Product. Installation instructions are provided for your convenience. AltRider is not responsible for any damages arising out of the installation, improper or otherwise, of the Product. No warranty of any kind, expressed or implied, is made regarding the safety of this Product.

To the extent allowed by law, AltRider shall not be held liable for any direct, indirect, punitive, incidental, special or consequential damages arising out of, or connected with, the use or misuse of this Product. Buyer assumes all risks and liability arising from use of this Product.

Entire Agreement

This document states the entire obligation of AltRider with respect to the Product. If any part of this agreement is determined to be void, invalid, unenforceable or illegal, including, but not limited to the warranty disclaimers and liability limitations set forth above, then the remainder of the agreement shall remain in full force and effect.

Applicable Law

This agreement is governed by the laws of Washington, USA. You hereby consent to the exclusive jurisdiction and venue of the courts of Washington, USA, in all disputes arising out of or relating to the use of this product.

